

DW LED

Project Name:	
Type:	



APPLICATION

LED premium grade enclosed and gasket fixture. For use in both indoor and outdoor applications where dust and moisture resistance and other non-hazardous contaminants. It is often used in refrigerated areas, food processing facilities, kitchens, parking garages, car washes, schools, government facilities, public areas and industrial spaces with low to medium mounting heights.

FEATURES:

- UV-stabilized, Fully gasket fiberglass upper body with cold-rolled steel white finish reflector(wireway) and a high-impact acrylic DR crepe pattern LENS, securely positioned in a permanent, IP 65 and IP67 continuous poured in place sealing gasket.
- Internal crepe pattern allows a smooth exterior surface, clear crepe shallow lens acrylic DR or polycarbonate.
- The lens and upper components are locked into place by retaining latches, assuring a secure and tight seal.
- Captive non-metallic snap-action latch cam secures lens to housing. Optional stainless steel latch.
- White end plugs 7/8" Housing end holes (2) - Snaps and locks tight to maintain tight seal of unused end holes.
- Smooth edges for easy handling.
- Tamper resistant (TR) option prevents the lens from being removed by unauthorized personnel. Tamper proof driver cat. #TPDT required (sold separately).

MOUNTING:

- Chain, swivel stem and surface mounting.
- Mounting brackets provided. (Stainless steel brackets)

LED:

- Color Temperature: 2700/3000/3500/4000/5000 (K).
- LED Module: High efficiency up to 162 LPW.
- Calculated L70: 122,000 hours
- Reported L70: +60,000 hours
- Poke in wire connectors.
- Color Rendering Index: 80+

ELECTRICAL:

- High power factor electronic driver, operate from a 120~277 Vac input range, 50 / 60 Hz.
- Generic: 0-10V Dim to 10%(GR).
- Power Factor: +0.9
- Efficiency: +85%
- Ambient Operating Temperature: -4°F (-20°C) ~ 122°F (50°C) (Std.). -40°F (-40°C) ~ 122°F (50°C) (with LT option) -31°F (-35°C) ~ 140°F (60°C) (with HT option)
- Constant Current, Class 2
- <ELCU-200>
- Guarantees emergency lighting remains ON or is turned on when power to the control device is lost.
- Interfaces with fire alarm panel or security system.
- "Watchdog" feature allows emergency loads to be controlled in tandem with normal power loads.
- UL listed for use in emergency circuits.

LISTING:

- F1 weatherability rating.
- UL 5V flame rating (ASTM D635-74).
- UL/CUL listed and labeled.
- Listed to UL 1598 and UL 8750.
- Suitable for damp / wet location listed.
- IP Rating: IP65 and IP67.
- CEC Compliant EM (please contact for more information)
- Made in USA.
- ARRA and BAA compliant.
- Trade Agreements Act compliant (optional).
- 5 years limited warranty.
- NSF International certified.
- U.S. Department of Agriculture.
- Canadian Standard Association.
- Bluetooth Mesh System available, please contact factory for more information.

CONFIGURATIONS

	Model #	AC Input	Lumen Output	Lumen Efficiency
2FT	18LED	18W	2837 lm	157 lm/W
	20LED	20W	3152 lm	
	27LED	27W	4256 lm	
	36LED	36W	5675 lm	
4FT	22LED	22W	3467 lm	
	36LED	36W	5675 lm	
	45LED	45W	7093 lm	
	56LED	56W	8827 lm	
	72LED	72W	11350 lm	
8FT	100LED	100W	15763 lm	
	72LED	72W	11350 lm	
	88LED	88W	13871 lm	
	112LED	112W	17654 lm	

: Based on 5000K.

LENS

	2FT	4FT	8FT	
DRS	O	O	O	Shallow acrylic lens in crepe pattern. 15% DR
DRD	X	O	O	Deep acrylic lens in crepe pattern. 15% DR
ARS	O	O	O	Shallow acrylic lens in crepe pattern. 50% DR
PCS	X	O	X	Shallow polycarbonate lens in prismatic pattern
TA1F	X	O	O	Tapered 100% Frosted High Impact Acrylic. Frosted
TAH	O	O	O	Tapered acrylic lens with prismatic lengthwise pattern & crepe end pattern. 50% DR
TAM	O	O	O	Tapered acrylic lens with prismatic lengthwise pattern & crepe end pattern. 15% DR

DW LED

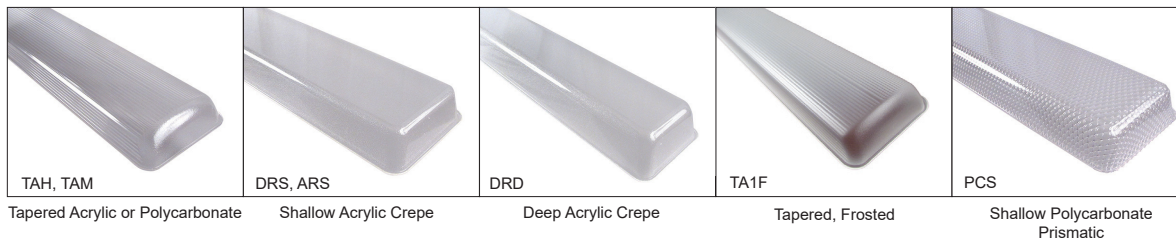

[Tapered Lens]



[DRS Lens]

ORDERING INFORMATION

EXAMPLE: DW-4-45LED-50K-HE-UNV-DRS

MODEL	LENGTH		LED		COLOR TEMP.		EFFICACY		CRI	
							HE	High Efficacy (Std.)	(Blank) C9	80+ CRI 90+ CRI ⁸
DW	2	2' Length	18LED	18W LED	-27K	2700K ⁷	HE	High Efficacy (Std.)	(Blank) C9	80+ CRI 90+ CRI ⁸
			20LED	20W LED	-30K	3000K				
			27LED	27W LED	-35K	3500K				
			36LED	36W LED	-40K	4000K				
	4	4' Length	72LED	72W LED	-50K	5000K				
			100LED	100W LED						
			22LED	22W LED						
			36LED	36W LED						
			45LED	45W LED						
8	8' Length	56LED	56W LED							
		72LED	72W LED							
		88LED	88W LED							
		112LED	112W LED							

* Contact factory for custom wattage or lumen requirement.

VOLTAGE		LENS ¹²		LED DRIVER	
UNV	120-277V	DRS	Shallow acrylic lens in crepe pattern. 15% DR (Std.)	GR	Generic, 0-10V 10% dim (Std.) ⁶
120	120V	DRD	Deep acrylic lens in crepe pattern. 15% DR ⁵	DM1	Generic 0-10V 1% dim
277	277V	ARS	Shallow acrylic lens in crepe pattern. 50% DR	SD40	40% / 100% Bi-Level Step dim
347	347V	PCS	Shallow polycarbonate lens in prismatic pattern ⁴	SDXX	XX% / 100% Bi-Level Step dim (Specify XX : 10% ~ 70%)
480	480V	TA1F	Tapered 100% Frosted High Impact Acrylic. Frosted ⁵	TD30/70	30% / 70% / 100% Tri-Level Step dim
		TAH	Tapered acrylic lens with prismatic lengthwise pattern & crepe end pattern. 50% DR	TDXX/YY	XX% / YY% / 100% Tri-Level Step dim (Specify XX, YY : 10% ~ 70%)
		TAM	Tapered acrylic lens with prismatic lengthwise pattern & crepe end pattern. 15% DR	ES566	eldoLED SOLOdrive Natural Dimming to dark, 0-10V, 100% ~ 0.1% dim
				EC	eldoLED ECOdrive 0-10V natural dim to 1% (Hybrid HydraDrive)
				LDE1	Hi-lume 1% EcoSystem LED driver with Soft-on, Fade-to-Black dimming technology, 100% ~ 1% dim
				BLT	Bluetooth Mesh System (contact factory for more information)

DW LED

DISTRIBUTION		CONTROLS		OPTIONS	
(Blank) W	Normal Wide	WDMS RS-LRD LRD-509S-x	Wet Location Day Light Motion Sensor, Fail on Remote programmer for LRD-509S and LRS-50 9S Fixture external mount 0-10V SmartDIM or multi-level high/low dim control occupancy sensor, Fail on (*IR remote programmable), (See note 11 to select lens for "x") ^{10, 13}	EMG8 EMG15 EMG20 EMG25 BSL718	1296 LUMEN EM Battery Backup (CEC Compliant EM) ^{3, 2} 2430 LUMEN EM Battery Backup (CEC Compliant EM) ^{3, 2} 3240 LUMEN EM Battery Backup (CEC Compliant EM) ^{3, 2} 4050 LUMEN EM Battery Backup (CEC Compliant EM) ^{3, 2} BODINE 18W EM Battery Backup (CEC Compliant) -4°F (-20°C) ~ 140°F (60°C)
		LMD-109	Fixture integrated High Frequency Doppler occupancy sensor with Bi-level dimming control, Fail on	BSL20	BODINE 20W EM Battery Backup (CEC compliant EM) 32°F (0°C) ~ 122°F (50°C)
		HC403	Microwave bi-level Occupancy Sensor, adjustable via DIP switch ¹⁴	CWEM6	6W EM Cold Weather -4°F (-20°C) ~ 131°F (55°C)
		EFS01RE	Fixture External mount 0-10V Bi-Level Dimming Occupancy PIR Sensor. Daylight Harvesting. (adjustable by Remote Control only-RM51)	ELCU-200	Fail-to-on Emergency lighting, UL924 ⁹
				GTD	Bodine Generator Transfer Device
				GTD10DIM	Bodine Generator Transfer Device (0-10VDC Dimmer Override)
				CS6	Watertight connector with 6ft water-resistant cord installed
				PW6	Pre-wired 6' Whip Flex #18/3
				AB	Two Ballast AB Switch
				MR4	MIRO4 Reflector (Gear Tray Reflector)
				GLR	Fast Blow Fuse ²
				GMF	Slow Blow Fuse ²
				WMS	Wet Location Occupancy Sensor
				SSL	Stainless Steel Latch
				TRSSL	Tamper-Proof Stainless Steel Cam-Action Latch
				TRDT	Tamper-Proof Driver Tool
				BRKT1	External Stud Mounting Bracket
				BRKT2	Pendant Mounting Bracket for 1/2" stem
				DC021	One end 7/8" Water Tight Die-Cast Fitting Assembly for 1/2" Rigid Conduit
				DC022	Both ends 7/8" Water Tight Die-Cast Fitting Assembly for 1/2" Rigid Conduit
				TRAYMSS	Stainless Steel Gear Tray Mounting Clip
				LT	Low Temperature for freezer (-40°F (-40°C) ~ 122°F (50°C))
				HT	High Temperature (-31°F (-35°C) ~ 140°F (60°C))
				AMB	Anti-Microbial Coating (Matte Skye White)
				HRC-05	Handheld Remote for HC403
				RM51	Handheld Remote for EFS01RE
				TAA	Trade Agreements Act compliant

LIGHTING CONTROL SYSTEM	
PPA102S	<Bluetooth> Bluetooth Powerpack (Consult factory for installation location)
CASAMBI	Contact factory for CASAMBI READY options

NOTES:

- N/A with DW2. 84% Light transmission rate. Light loss factor compared to DRS is less than 3%.
- Must specify voltage, not available with 347V.
- Contact factory for other emergency ballast options.
- Available with 4ft.
- Available with 4ft and 8ft.
- To find an approved dimmer switch, please see table 1.
- Available with C9 only.
- Lumen per watt is around 15% less than standard CRI (80+).
- Shipped separately.
- Its default setting can be found on the IR-TEC installation instructions.
- A: Standard cone shape Lens @ 15' height (up to 30' coverage)
B: Extra wide cone shape Lens @ 10' height (up to 60' coverage)
C: High bay cone shape Lens @ 30' height (up to 90' coverage)
D: Standard round shape Lens @ 20' height (up to 40' coverage)
F: Extra wide dome shape Lens @ 20' height (up to 80' coverage)
G: Aisle way arch shape Lens @ 40' height (up to 120' coverage)
- DR is a rubber modifier that improves the impact resistance of acrylic.
"DR it's an additive to the Acrylic material that make it sturdy or stronger acrylic. Say 15%DR is the most common thk on Acrylic, then there's the 50% DR the high Impact and the 100%DR is high impact with creep lengthwise pattern on Tapered lens. but even if it's 100% DR it is not considered a vandal resistant lens yet."
- Order "RS-LRD" to adjust sensor setting.
- Integrated Microwave bi-level Occupancy Sensor, adjustable via DIP switch(Mounted inside fixture).

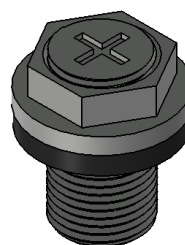
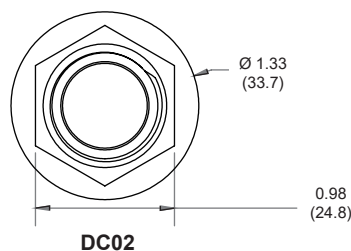

DW LED

APPROVED DIMMER SWITCH (Table 1)

	Manufacturer	Manufacturer Part #
GR	LUTRON	NTSTV-DV
	LEVITON	IP710-DLZ
PH	LUTRON	Nova: NFTV- dimmer plus PP-DV relay pack(s) Nova T: NTSTV-DV-dimmer Diva: DVTV-dimmer, DVSCSTV-dimmer, plus PP-DV relay pack(s), DVSTV-dimmer, DVSCSTV-dimmer GRAFIK Eye QS: QSGRJ-XP, plus GRX-TVI 0-10V interface GRAFIK Eye QS with EcoSystem: QSGRJ-XE, plus GRX-TVI 0-10V interface PowPak: RMJ-5T
	LEVITON	Leviton: IP710-LFZ
	PHILIPS	Sunrise - SR1200ZTUNV
OS, OS1	OSRAM	ZBHA-CLM DIM (NAED:45678)
	ENCELIUM EMS	EN-LCM-1R10V-GB2-BK EN-LCM-1R10V-GB2-BK/DR EN-ALC-1R10V-GB2-BK EN-ALC-1R10V-GB2-BK-DR
	LEVITON	IP710-DLX
	LUTRON	DVTV-XX
	WATTSTOPPER	ADF-120277
	SYNERGY LIGHTING CONTROLS	ISD BC
	WATTSTOPPER	FD-301
	WATTSTOPPER	FSP-202
ENLIGHTED INC.	SU-3E-00 (Enlighted Compact Sensor)	

* If you want other specific kind, please contact us.



HC403 FACTORY SETTING (TABLE 2)

Detection Area	100%
Hold-time	5 sec
Daylight sensor	Disable
Stand-by period (tri-level control)	10 sec
Stand-by dimming level	10%

* See a separate attachment to find more setting options.

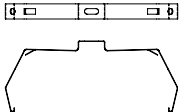
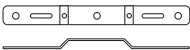
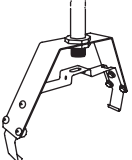
GASKET ENCLOSURES ACCESSORIES

STANDARD		Standard Bracket
BRKT1		External Stud Mounting Bracket
BRKT2		Pendant Mounting Bracket for 1/2" stem

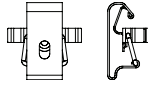
DC02		7/8" Die-Cast Fitting Assembly for 1/2" Rigid Conduit
TRAYMSS		Stainless Steel Gear Tray Mounting Clip
TRSSL		Tamper-Proof Stainless Steel Cam-Action Latch

* Note: Silicon sealant should be applied to internal threads when installed for wet locations.

DW LED

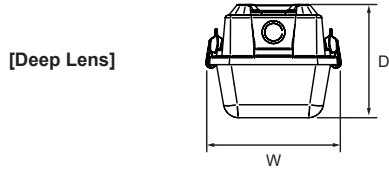

Specifications: Deep
 Length: 25-7/8 (657.2), 50 (1270),
 98 (2489.2)
 Width: 6-5/8 (168)
 Depth: 5-7/8 (149)

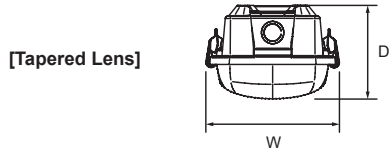

Specifications: Tapered
 Length: 25-7/8 (657.2), 50 (1270),
 98 (2489.2)
 Width: 6-5/8 (168)
 Depth: 4-7/8 (123)

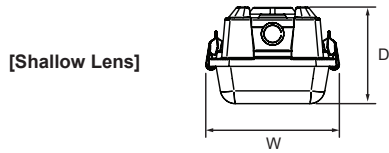

Specifications: Shallow
 Length: 24 (609.6), 48 (1219.2)
 Width: 6-5/8 (168)
 Depth: 5 (127)
 All dimensions are in inches (millimeters).

MOUNTING INFORMATION:

2' DW Series

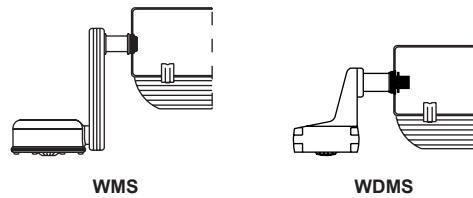
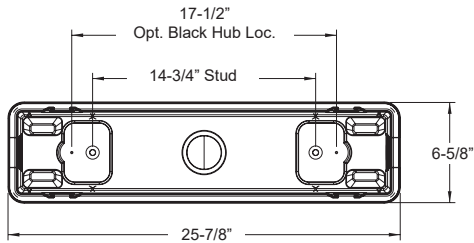

4' DW Series

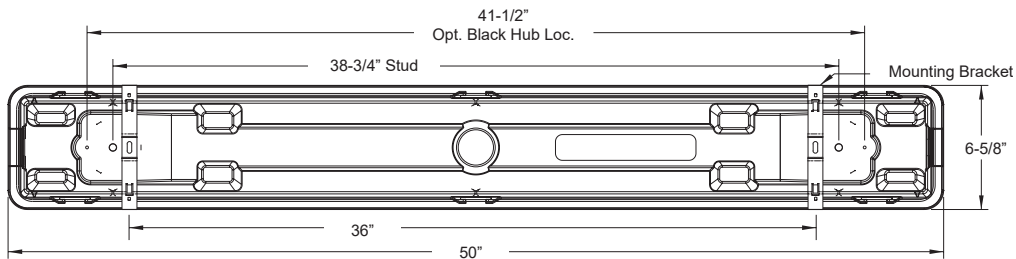

8' DW Series

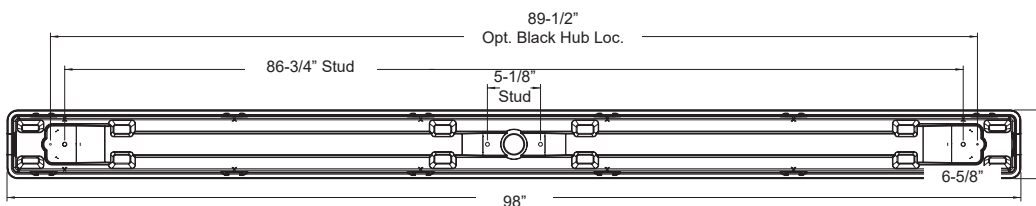

DW LED

DW-2-18LED

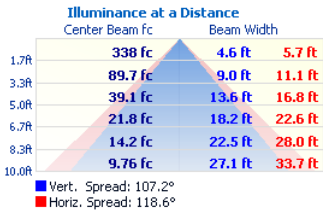

DW-2-20LED

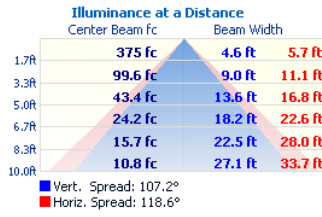

DW-2-27LED

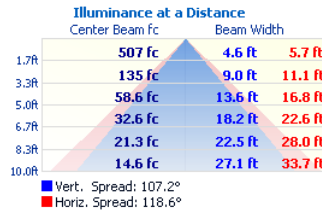

DW-2-36LED

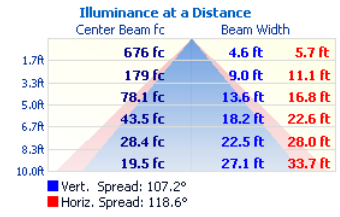

DW-4-22LED

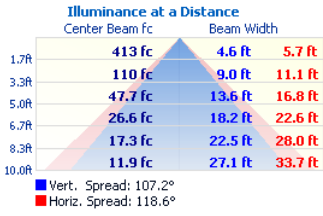

DW-4-36LED

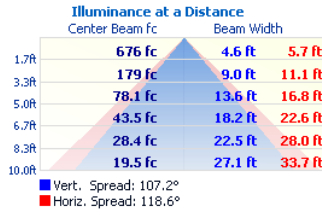

DW-4-45LED

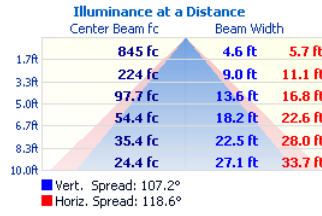

DW-4-56LED

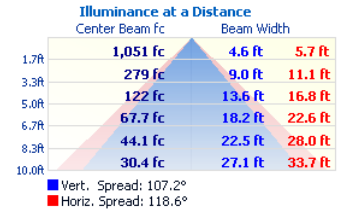

DW-4-72LED

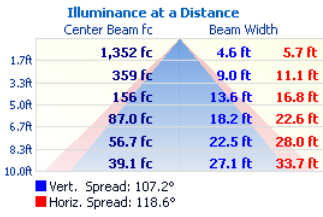

DW-4-100LED

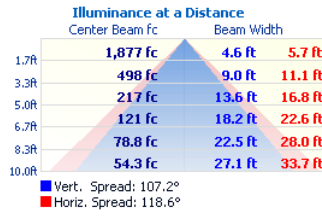

DW-8-72LED

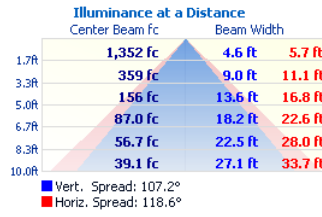

DW-8-88LED

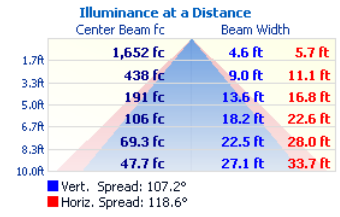

DW-8-112LED

