

# ED exit sign INSTALLATION INSTRUCTIONS

## READ AND FOLLOW ALL SAFETY INSTRUCTIONS

**IMPORTANT SAFEGUARDS:** When using electrical equipment, basic safety precautions should always be followed, including the following:

1. Do not use outdoors.
2. Do not let power supply cords touch hot surfaces.
3. Do not mount near gas or electrical heaters.
4. Equipment should be mounted in locations and at heights where it will not readily be subjected to tampering by unauthorized personnel.
5. Use caution when servicing batteries. Battery acid can cause burns to skin and eyes. If acid is spilled on skin or eyes, flush acid with fresh water and contact a physician immediately.
6. The use of accessory equipment not recommended by the manufacturer may cause an unsafe condition. Any modification or use of non-original components will void the warranty and product liability.
7. Do not use this equipment for other than intended use.
8. Servicing of this equipment should be performed by qualified service personnel only.
9. Disconnect AC power supply before servicing.
10. Unpack and check for concealed transit damage.
11. Report any transit damage to delivering carrier and file claim.



## SAVE THESE INSTRUCTIONS!

**WARNING:** MAKE SURE THAT POWER IS OFF BEFORE MAKING ANY ELECTRICAL CONNECTIONS!

### WIRING DIAGRAMS:

- WHITE: Return for 120VAC or 277VAC wiring
- BLACK: Hot lead for 120VAC wiring
- RED/ORANGE: Hot lead for 277VAC wiring
- GREEN: Equipment ground

1. Make sure that all wires are carefully tucked away from the cavity behind the plastic inset.
2. Plug the mating connector of the battery to the PC board.
3. Unused wires must be capped using enclosed wire nuts.

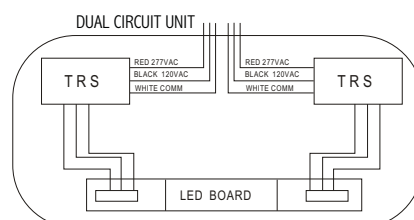
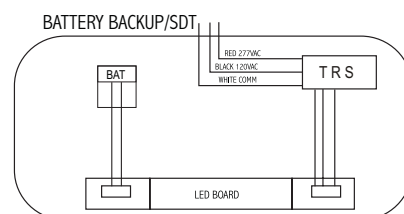
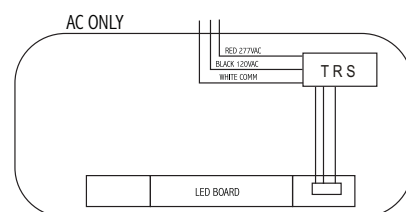

# ED exit sign INSTALLATION INSTRUCTIONS

## CANOPY MOUNTING (Top or Side-end mount):

1. Remove face plate cover by pulling equally at the outer rim of the face plate on two opposite sides. Remove ground wire from face plate (Figure F).
2. Pop out the plastic mounting hole cover on the top or the side of the sign. Place one of the nuts from threaded stem rod in the slot inside the housing just inside of the unit (Figure A).
3. Feed the AC supply and ground wire through the nut & hole and out of the sign housing (Figure B).
4. Secure the canopy J-Box cover to the mount area of the exit sign by inserting it and shifting it over to align the hole.
5. Feed AC supply wires and ground wire through threaded stem and screw stem into nut inside unit. Screw the remaining nut for the threaded stem onto the stem and tighten securely to complete the mounting of the canopy to the exit sign (Figure C).
6. Determine the position the exit needs to be mounted (the way the face needs to be pointed). Use the included round J-Box mounting plate and small #8-32 screws to accomplish (Figure D).
7. Make connection with the AC supply wires in the J-Box as described in the electrical connection section of this instruction.
8. Now mount the sign to the J-Box plate with the (2) #8-32 screws provided and tighten securely (Figure E).
9. Remove the proper chevron(s) from the EXIT legend(s) if necessary. Re-attach the ground wire to the face plate (Figure F).
10. Attach battery jumper wire (where applicable) to PC board and replace face plate back on unit to complete installation.

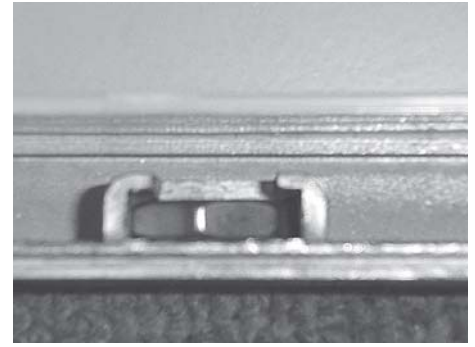

FIGURE A

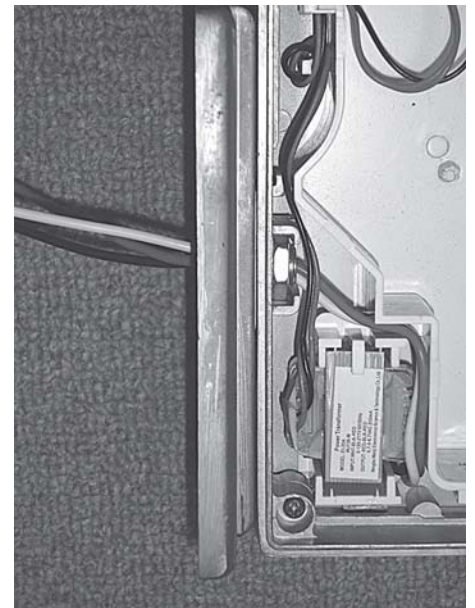

FIGURE B

## FLUSH MOUNTING

1. Remove face plate cover by pulling equally at the outer rim of the face plate on two opposite sides. Remove ground wire from face plate (Figure F).
2. Remove the center KO and also required KOs that will match the junction box.
3. Route the wires through the center knock-out. Make electrical connections inside the junction box as described in the electrical connection section of this instruction sheet. Push wires back against the back of the sign to minimize any of the wires interfering with the illumination of the letters.
4. Now mount the sign to the J-Box.
5. Remove the proper chevron(s) from the EXIT legend(s) if necessary. Re-attach the ground wire to the face plate (Figure F).
6. Attach battery jumper wire (where applicable) to PC board and replace face plate back on the unit to complete installation.

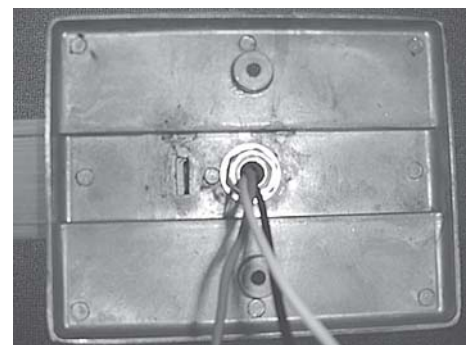
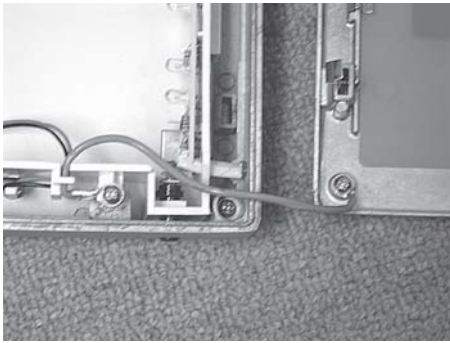

FIGURE C

Contractor is responsible for adequately reinforcing ceilings to support luminaire weight. Utopia Lighting accepts no responsibility for inadequately reinforced ceilings. The information contained in this drawing is the sole property of Utopia Lighting.

Any reproduction in part or whole without the written permission of Utopia Lighting is prohibited and warranty is voided.

# ED exit sign    INSTALLATION INSTRUCTIONS



**FIGURE F**



**FIGURE E**

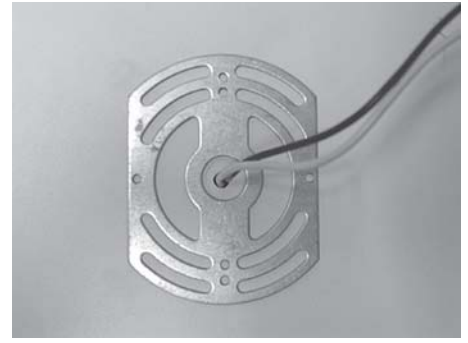

**FIGURE D**

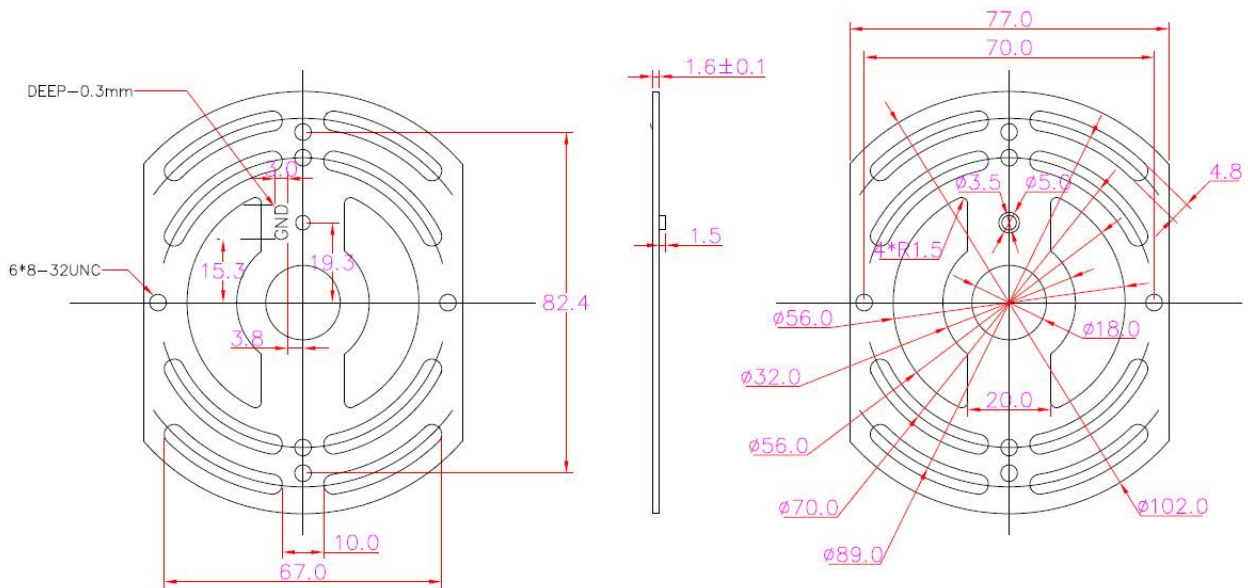

Dimensions for **FIGURE D** shown in mm.

Contractor is responsible for adequately reinforcing ceilings to support luminaire weight. Utopia Lighting accepts no responsibility for inadequately reinforced ceilings. The information contained in this drawing is the sole property of Utopia Lighting.

Any reproduction in part or whole without the written permission of Utopia Lighting is prohibited and warranty is voided.

# ED exit sign INSTALLATION INSTRUCTIONS

## INSTRUCTION FOR SELF-DIAGNOSTIC TEST:

### 1. Introduction

Once the unit is properly installed according to the Installation instruction sheet and AC power is supplied, the EXIT will come ON. The dual-color LED indicator will also come ON, automatically initiating the self-diagnostic test function. The LED indicator points out the current unit status. A STEADY GREEN on the LED indicator indicates a normal service; BLINKING GREEN indicates that the unit is in testing mode; GREEN/RED FLASHING indicates that the battery is charging; RED (STEADY and BLINKING) would indicate a fault or a service alert. Refer to section 3 – Fault Indication for more details. The LED indicator would be OFF when the unit is in Emergency mode.

### 2. Self – Diagnostic Service

The self-diagnostic function is factory preset without any field adjustment. The automatic self-diagnostic feature serves the following tests –

- On-line real time monitoring of battery and LED(s): Identifies battery charging, disconnection and failure along with LED failures.
- Self-testing and a 30-second discharge once every 30 days (conforming to NFPA code requirements), after AC power has been supplied for a minimum of 24 hours.
- Self-testing and a 30-minute discharge once every 180 days, after AC power has been supplied for a minimum of 24 hours.
- Self-testing and a 90-minute discharge once every 365 days (conforming to NFPA code requirements), after AC power has been supplied for a minimum of 24 hours.

### 3. Fault Indication

FAULT DESCRIPTION	LED INDICATION
Battery disconnection	STEADY Red
Battery recharge failure	FLASHING Red
Battery failure	Red BLINKING '2' times
LED failure	Red BLINKING '3' times

\* A battery recharge failure is more likely seen after a monthly or annual auto-discharge

\*\* A battery failure is more likely seen when the unit goes into a monthly/annual discharge test and/or fails to run the LED strip for the designated amount of time in Test/Emergency mode

### 4. Manual Testing

This unit also provides for manual testing by pushing the test switch in a specific pattern. The different patterns and the resulting tests are listed in the table below.

ACTION	REACTION AND LED INDICATION
Push test button Once (within 2 seconds)	30-second test: FLASHING Green
Push test button Twice (within 2 seconds)	30-minute test; Green BLINKING '2' times
Push test button Thrice (within 2 seconds)	90-minute test; Green BLINKING '3' times
Push and Hold test button (for 3-5 seconds)	Interruption
Push and Hold test button (for more than 6 seconds)	System reset

### 5. Operation

During an electrical power failure, the LED strip will transfer into Emergency mode and stay LIT for a minimum of 90 minutes. To test this unit, the battery needs to be charged initially for 2 hours before depressing the test switch (to do manual test). On pressing the test switch, the LED strip will transfer into a SIMULATED Emergency mode with the LED indicator FLASHING/BLINKING Green. The LEDs will turn OFF after 30 seconds/30 minutes/90 minutes respectively.