

LAL

Project Name:	
Type:	



APPLICATION

LED Shoebox/Area Light series can be used in parking lot, urban roads, industrial areas, residential areas, sidewalks, schools, and gardens. Wide detection area, range up to 50FT in diameter.

FEATURES:

- Rugged, One-piece die cast aluminum housing.
- Die-cast integral heat sink to provide thermal management.
- Low profile, 3G vibration rated compact design minimizes wind load requirements.
- Housing is completely sealed against moisture and environmental contaminants.
- Operating temperature: -40°C to 40°C (-40°F to 104°F)
- Suitable for mounting heights up to 50ft.
- Field adjustable CCT & Wattage.

MOUNTING:

- Slip Fitter (for 2-3/8" pole).
- Square / Round pole arm.
- Wall mount.
- Trunnion mount.
- Adjustable square pole mount.

ELECTRICAL:

- 0-10V dimming standard.
- 120-277V, 50/60Hz, 347-480V optional.
- THD: ≤20%
- PF: ≥90%
- 10kV (120-277V), 20kV (347-480V) as standard.

OPTIC:

- PC optic.
- Distribution: Type2, Type3, Type4, Type5
- House side shield, glare shield and back light control shield options are available.

LISTING:

- UL listed.
- DLC listed. ¹
- Suitable for wet location.
- 5 years limited warranty.
- ARRA compliant (optional).
- TAA compliant. (optional). ²

LED:

- Toyoda LED
- Color Temperature: field adjustable 30/40/50K
- Lumen efficiency: Color rendering index: >70
- Life span: 100,000 hours
- Lumen Maintenance L70 greater than 100,000 hours IESNA TM-21.

ORDERING INFORMATION

EXAMPLE: LAL-140SLED-3T-UNV-BZ-SF

MODEL	LED	COLOR TEMP.	DISTRIBUTION	VOLTAGE
LAL	100SLED Field Selectable 40/60/80/100W LED 140SLED Field Selectable 60/90/120/140W LED 180SLED Field Selectable 72/108/144/180W LED 250SLED Field Selectable 100/150/200/250W LED 300SLED Field Selectable 120/180/240/300W LED	-3T Field Selectable 30/40/50K	T2 Type II T3 Type III T4 Type IV T5 Type V	UNV HV 120-277V (Std.) 347-480V
	400SLED Field Selectable 300/320/360/400W LED	-2T Field Selectable 40/50K		

FINISH	MOUNTING	OPTIONS
BZ Dark Bronze RAL#8019 (Std.) *BK Black RAL#9011 *WH White RAL#9016 *GR Gray RAL#7045 **CC Custom Color * Non-standard finish with extra charge. ** Additional charge & set up fee.	SF Slip Fitter (2-3/8" O.D) PMS Square Pole Mount Arm (4-5") PMR Round Pole Mount Arm (4"-5" dia.) WM Wall Mount TR Trunnion Mount ASM Adjustable square pole mount	TLPC3 3-Pin Receptacle and Twist Lock Photocell Installed 120V-277V TLPC4 3-Pin Receptacle and Twist Lock Photocell Installed 480V RC7 NEMA 7-wire receptacle only (120-277V) BRI823 Integrated Bi-level occupancy sensor with daylight, 0-10V, adjustable via DIP switch ANT-6-4T Plug-and-Play Bi-Level PIR Sensor RC-100 Remote control for the BRI sensor ARRA Assembled in USA TAA TAA compliant BLC Back light control shield HS House Side Shield GS Glare Shield ZINC Zinc powder coating, an anti-corrosive primer (applied on top of selected finish) CASAMBI Contact factory for CASAMBI READY options

NOTES:

1. DesignLights Consortium® (DLC) qualified product. Not all versions of this product may be DLC qualified. Please check the DLC Qualified Products List at www.designlights.org/QPL to confirm which versions are qualified.
2. It is not possible to select it with the ARRA option.



LAL

CONFIGURATIONS

Series	Model#	AC Input	Distribution	3000K		4000K		5000K		B.U.G.
				Lumens	Lumens / Watt	Lumens	Lumens / Watt	Lumens	Lumens / Watt	
LAL	100SLED	40W	T3	6400 lm	160 lm/W	6800 lm	170 lm/W	6560 lm	164 lm/W	B3-U0-G3
		60W		9300 lm	155 lm/W	10000 lm	167 lm/W	9600 lm	160 lm/W	
		80W		12000 lm	150 lm/W	13000 lm	163 lm/W	12500 lm	156 lm/W	
		100W		14500 lm	145 lm/W	15800 lm	158 lm/W	15000lm	150 lm/W	
	140SLED	60W		9700 lm	162 lm/W	10600 lm	177 lm/W	10000 lm	167 lm/W	B3-U0-G3
		90W		14000 lm	156 lm/W	15500 lm	172 lm/W	14500 lm	161 lm/W	
		120W		18000 lm	150 lm/W	20000 lm	167 lm/W	18500 lm	154 lm/W	
		140W		20000 lm	143 lm/W	23000 lm	164 lm/W	21000 lm	150 lm/W	
	180SLED	72W		10500 lm	146 lm/W	11500lm	160 lm/W	10800 lm	150 lm/W	B3-U0-G3
		108W		15300 lm	142 lm/W	16800lm	156 lm/W	15700 lm	145 lm/W	
		144W		20200 lm	140 lm/W	22000lm	153 lm/W	20600 lm	143 lm/W	
		180W		24800 lm	138 lm/W	27000lm	150 lm/W	25200 lm	140 lm/W	
	250SLED	100W		14500 lm	145 lm/w	16000 lm	160 lm/w	14800 lm	148 lm/w	B4-U0-G4
		150W		21300 lm	142 lm/w	23200 lm	155 lm/w	21800 lm	145 lm/w	
		200W		27500 lm	138 lm/w	30400 lm	152 lm/w	28400 lm	142 lm/w	
		250W		33500 lm	134 lm/w	37000 lm	148 lm /w	34500 lm	138 lm /w	
	300SLED	120W		19200 lm	160 lm/W	21500 lm	179 lm/W	20000 lm	167 lm/W	B4-U0-G4
		180W		28000 lm	156 lm/W	30000 lm	160 lm/W	28500 lm	158 lm/W	
		240W		35000 lm	146 lm/W	38500 lm	167 lm/W	36000 lm	150 lm/W	
		300W		41000 lm	137 lm/W	45000 lm	179 lm/W	42000 lm	140 lm/W	
400SLED	300W	-	T2	-	-	47000lm	162 lm/W	46000 lm	159 lm/W	B5-U0-G5
	320W	-		-	51000lm	159 lm/W	50000 lm	156 lm/W		
	360W	-		-	56000lm	156 lm/W	55000 lm	153 lm/W		
	400W	-		-	60500lm	151 lm/W	60000 lm	150 lm/W		

EPA OF AREA LIGHT

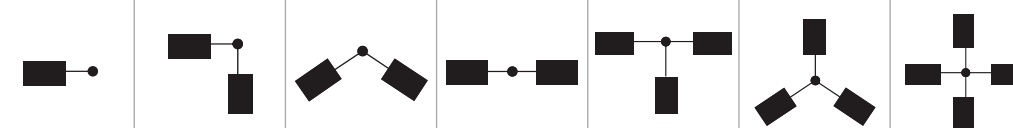
Item	Mounting							
		1	2 @90°	2 @120°	2@180°	3 @90°	3 @120°	4 @90°
100 / 140 / 180SLED	Pole Mount	0.3632	0.6849	0.8861	0.7264	1.0481	1.2078	1.0481
250 / 300 / 400SLED		0.4758	0.8091	1.059	0.9516	1.2849	1.3923	1.2849



HS (House Side Shield) option



GS (Glare Shield) option



BLC (Back Light Control Shield) option

All dimensions are in inches (millimeters).

100/ 140/ 180SLED

(Adjustable Square Mount)

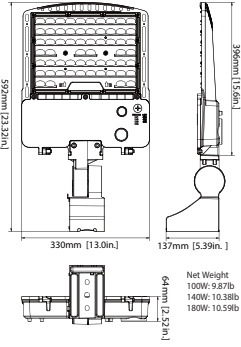

(Slip Fitter)

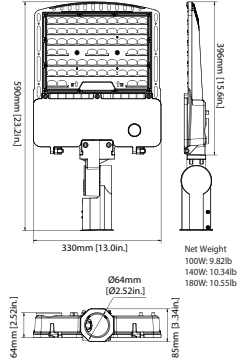

(Wall Mount)

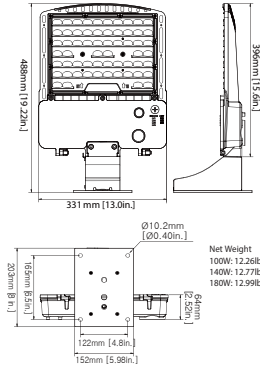

(Pole Mount)

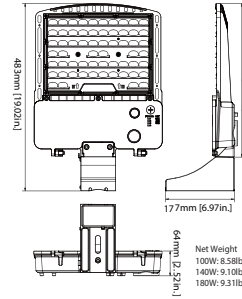

(Trunnion Mount)

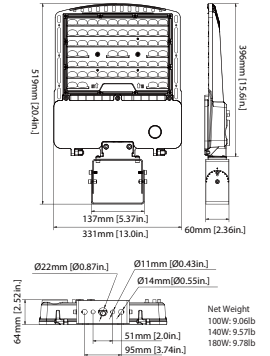

250/ 300/ 400SLED

(Adjustable Square Mount)

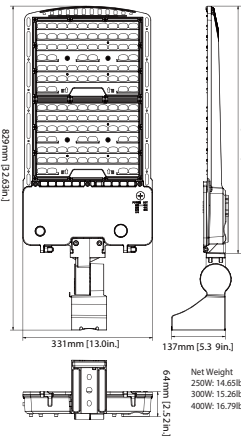

(Slip Fitter)

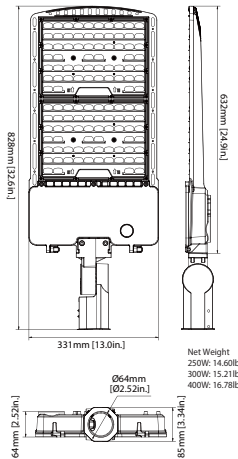

(Wall Mount)

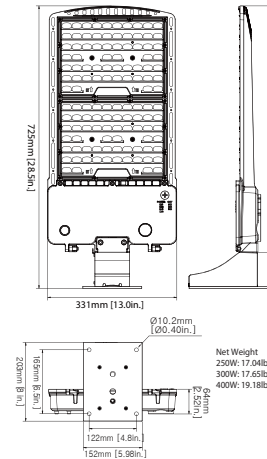

(Pole Mount)

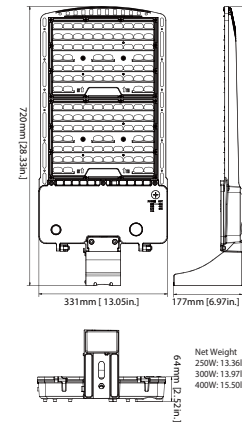

(Trunnion Mount)

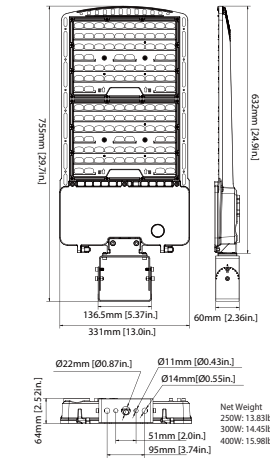

LAL

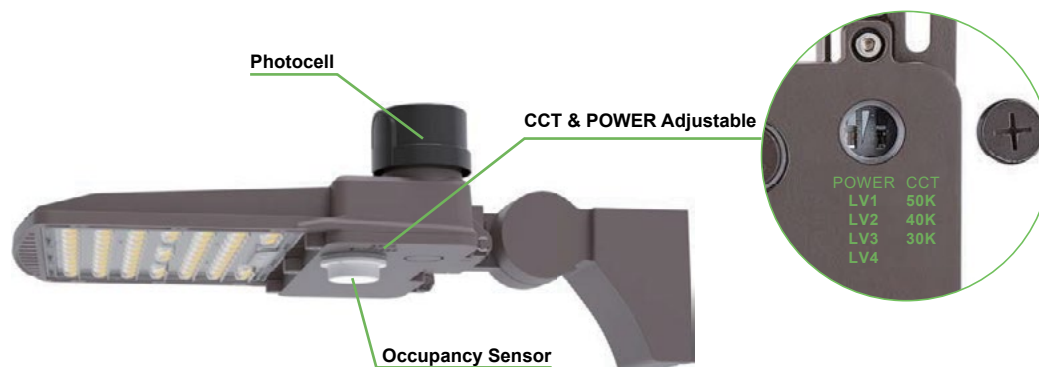

Sensitivity	100%
Stand-by time/Hold-time	10 Sec.
Detection	When sunlight (daylight) is detected
Dimming Level	20%
Dimming Time	24 hours (* It will dim when daylight is detected)

Detection angle	360°
Detection zone	Max. coverage 60' diameter from 40' height
High mode	0-10V/ default 10V
Low mode	Off / 0-9.8V / default 1V
Operating temperature	-104°F ~ 158°F (-40°C ~ 70°C)
Operating Humidity	20-90%
Rating	IP66

MOUNTING



PMS/R



SF



WM



TR

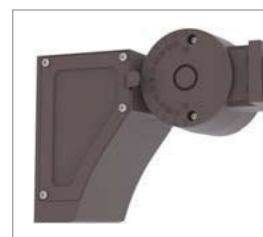

ASM

