

# LJD

Project Name:	
Type:	



### APPLICATION

LED commercial downlight LJD series are available in 4", 6", 8" and 10" with up to 60w. The fixture simply gets wired to a wall switch and placed into the ceiling - no can, bulb or extra labor required. It is designed and engineered for recessed applications, which is suitable for commercial and public places and elegantly decorates the ambience, such as shopping mall, hospital, airport, hotel lobby etc.

### FEATURES:

- The downlight is built with an integral junction box that eliminates the need for a traditional recessed housing and mounts directly into ceiling in the new construction and retrofit.
- Twist-lock modular design.
- Available in round and square trims.
- Integrated J-box for direct wire, eliminated recessed can.
- Spun aluminum reflector integrated with haze finish and white trim ring with shadow free.

### INSTALLATION:

- The fixture simply gets wired to a wall switch and placed into the ceiling - no can, bulb or extra labor required.
- Optional new construction frame available.
- Snaps into place for easy installation.
- Durable tension clips are allowing for fast and easy flush installation.

### LED:

- CCT And Wattage Adjustable.
- Class 2 high efficiency LED driver.
- +80 CRI
- THD <20
- Beam angle: ± 75°
- Color temperature: 3000/3500/4000(K)
- Operating Temperature: -4°F (-20°C) ~ 104°F (40°C).

### ELECTRICAL:

- 0-10V dimming which continuous dims to 10%
- Input Voltage: 120-347V
- Power Factor: +0.9
- Operating hours : 50,000 hours.

### LISTING:

- UL/CUL Listed.
- Tested to IESNA LM-79 and LM-80.
- Energy Star Listed.
- Suitable for Dry and Damp Location.
- ARRA compliant (optional).
- 5 years limited warranty.
- IC rated(LJD-3SL only).

### ENGINE

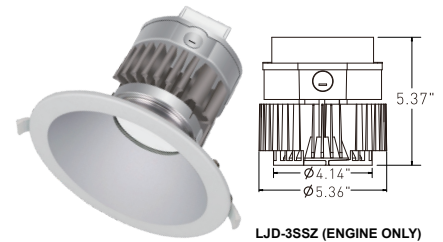

The height of completed downlight (LJD-3SL)

Size	Type	Height
4"	Round	5.43"
	Square	
	Square Wall Wash	5.71"
	Round Wall Wash	
6"	Round	5.43"
	Square	
	Square Wall Wash	5.89"
	Round Wall Wash	
8"	Round	6.02"
10"	Round	7.01"

The height of completed downlight (LJD-3SH)

Size	Type	Height
4"	Round	6.93"
	Square	
	Square Wall Wash	7.21"
	Round Wall Wash	
6"	Round	6.93"
	Square	
	Square Wall Wash	7.39"
	Round Wall Wash	
8"	Round	7.52"
10"	Round	8.51"

The height of completed downlight (LJD-3SS)

Size	Type	Height
6"	Round	7.34"
	Square	
8"	Round	7.93"
10"	Round	8.91"

# LJD

**ORDERING INFORMATION**

**EXAMPLE: LJD-3SL-3T-UNV-RT4**

MODEL	LED	COLOR TEMP.	VOLTAGE	REFLECTOR & TRIM	FINISH
<b>LJD</b>	<b>3SL</b> Selectable 10/15/20W LED (IC rated)	<b>-3T</b> Selectable 30/35/40K	<b>UNV</b> 120-347V	<b>RT4</b> Round Trim 4"	<b>(Blank)</b> Silver Reflector & White Trim Ring <b>TRBK</b> Black Trim Ring <b>TRSV</b> Silver Trim Ring <b>RFWH</b> White Reflector <b>RFBK</b> Black Reflector <b>WH</b> White Reflector and Trim Ring <b>BK</b> Black Reflector and Trim Ring <b>SV</b> Silver Reflector and Trim Ring
	<b>3SH</b> Selectable 27/34/40W LED (Non-IC rated)			<b>RT6</b> Round Trim 6"	
	<b>3SS</b> Selectable 40/50/60W LED <sup>1</sup> (Non-IC rated)			<b>RT8</b> Round Trim 8"	
	<b>RT10</b> Round Trim 10"				
	<b>ST4</b> Square Trim 4"				
	<b>ST6</b> Square Trim 6"				
	<b>RWT4</b> Round Wall Wash Trim 4"	<b>RWT6</b> Round Wall Wash Trim 6"	<b>SWT4</b> Square Wall Wash Trim 4"	<b>SWT6</b> Square Wall Wash Trim 6"	

OPTIONS		LIGHTING CONTROL SYSTEM	
<b>REM8</b>	8W Remote EM for field installation (provided with wall plate and EM pilot)	<b>PPA102S</b>	<u>&lt;Bluetooth&gt;</u>
<b>REM15</b>	15W Remote EM for field installation (provided with wall plate and EM pilot)		Bluetooth Powerpack (Consult factory for installation location)
<b>REM25</b>	25W Remote EM for field installation (provided with wall plate and EM pilot)		
<b>FK</b>	New Construction Frame Kit		
<b>FKJ</b>	New Construction Frame Kit with J-Box		
<b>ARRA</b>	Assembled in USA		

NOTES:  
1. 3SS is compatible only with 6"/8"/10" Round trims and 6" Square trim.

**CONFIGURATIONS**

	Input	LED Watts	Lumen Output	Lumen Efficiency
LJD-3SL	120-347V	10W	750 lm	75 lm/W
		15W	1170 lm	78 lm/W
		20W	1600 lm	80 lm/W

	Input	LED Watts	Lumen Output	Lumen Efficiency
LJD-3SH	120-347V	27W	2430 lm	90 lm/W
		34W	2890 lm	85 lm/W
		40W	3200 lm	80 lm/W

	Input	LED Watts	Lumen Output	Lumen Efficiency
LJD-3SS	120-347V	40W	4360 lm	109 lm/W
		50W	5300 lm	106 lm/W
		60W	6180 lm	103 lm/W

**FRAME KIT**

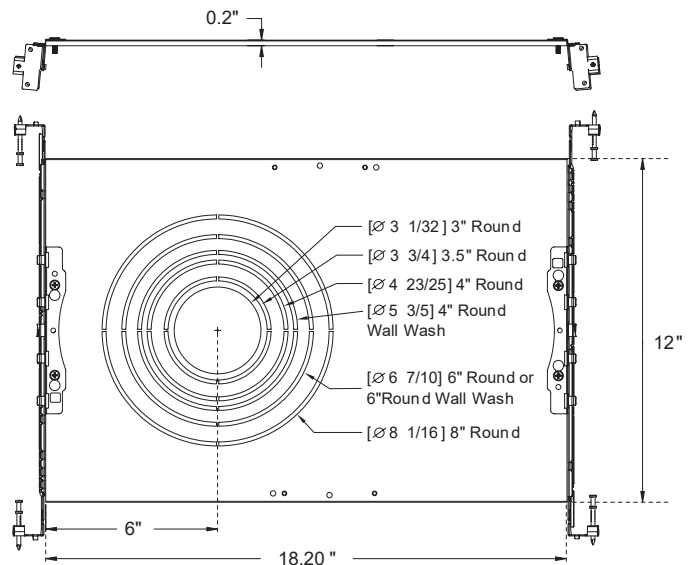
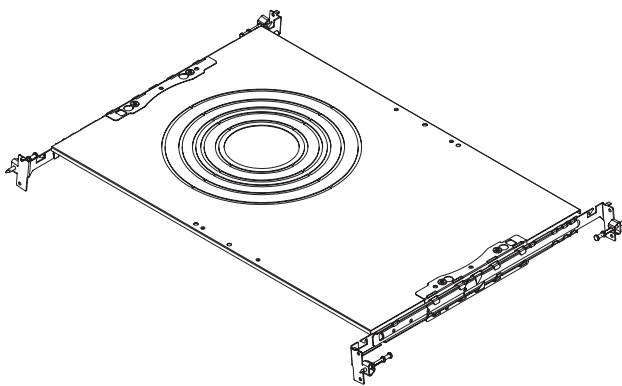

# LJD

## ROUND TRIM

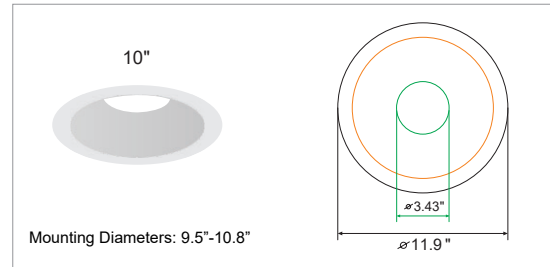
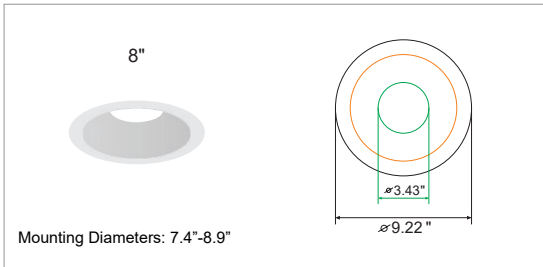
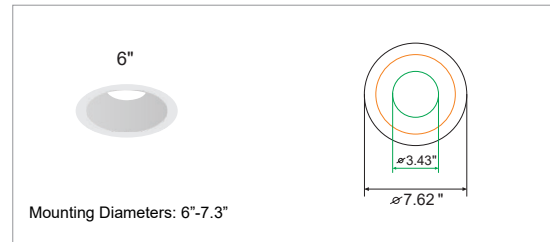
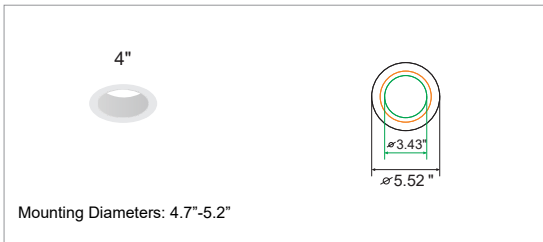

## ROUND WALL WASH TRIMS

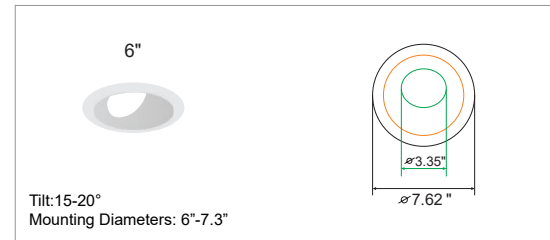
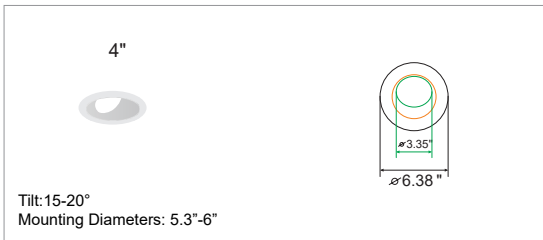

## SQUARE TRIMS

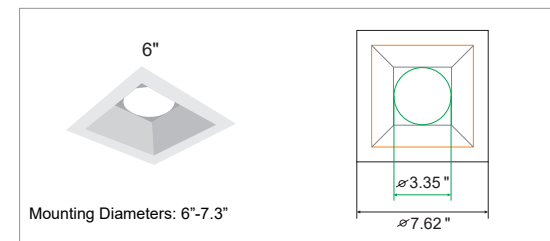
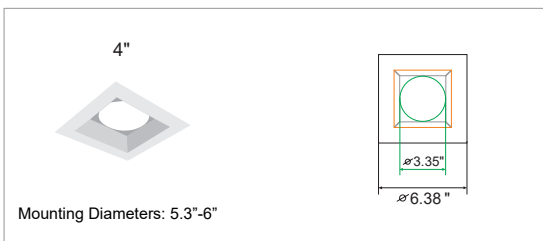

## SQUARE WALL WASH TRIMS

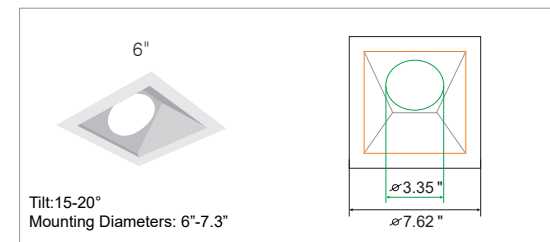
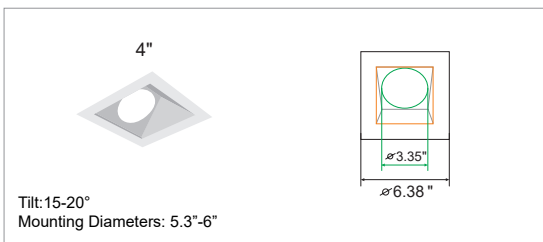

# LJD

## 6" 20W Square Trim

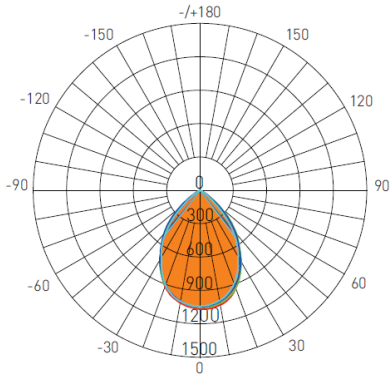

AVERAGE BEAM ANGLE(50%): 76.6°

Lumens: 1515.4 Lm  
 Watts: 20 W  
 LPW: 75.77 Lm/W  
 CCT: 4000K

UNIT: cd  
 C0/180, 75.1°  
 C30/210, 77.8°  
 C60/240, 78.3°  
 C90/270, 75.1°

### Zonal Flux Diagram

T	C0	C45	C90	C135	C180
10	1047	1022	1007	992.7	1027
20	939.2	932.1	893.4	892.4	922.1
30	719.9	739.1	687.3	709.4	711.5
40	471.7	497.7	440.1	477.0	457.8
50	170.8	280.1	158.0	250.7	159.6
60	32.27	62.15	30.20	46.44	33.23
70	2.699	4.711	3.380	4.018	3.231
80	1.543	2.277	2.065	2.620	1.965
90	0.1002	0.0711	0.1300	0.0681	0.1300
100	0.0406	0.0496	0.0406	0.0406	0.0451
110	0.0587	0.1195	0.1128	0.1015	0.1038
120	0.2476	0.3584	0.3114	0.3492	0.3024
130	0.6308	0.7486	0.6814	0.7350	0.7086
140	1.149	1.193	1.150	1.217	1.205
150	1.614	1.648	1.633	1.653	1.682
160	2.155	2.061	2.043	2.088	2.156
170	2.363	2.331	2.304	2.322	2.422
180	2.498	2.444	2.431	2.415	2.503
DEG	LUMINOUS INTENSITY:cd				

### Zonal Lumens

T	φ total
0-10	98.17
10-20	371.6
20-30	748.1
30-40	1122
40-50	1389
50-60	1490
60-70	1507
70-80	1510
80-90	1511
90-100	1511
100-110	1511
110-120	1512
120-130	1512
130-140	1513
140-150	1514
150-160	1515
160-170	1515
170-180	1515
	UNIT: lm

### Luminance cd/(m2)

G(DEG)	C0/180	C90/270
85	662	908
80	395	528
75	341	445
70	351	439
65	965	913
60	2869	2684
55	6050	5712
50	11807	10926
45	19770	18214

## 6" 20W Square Wall Wash

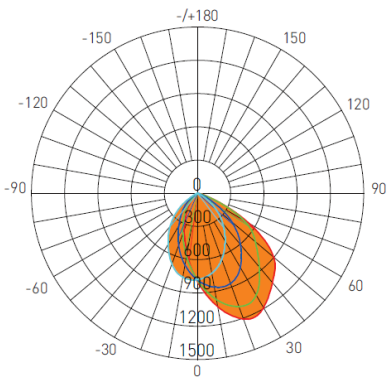

AVERAGE BEAM ANGLE(50%): 71.0°

Lumens: 1590.6 Lm  
 Watts: 20 W  
 LPW: 79.53 Lm/W  
 CCT: 4000K

UNIT: cd  
 C0/180, 65.4°  
 C30/210, 68.8°  
 C60/240, 72.5°  
 C90/270, 77.0°

### Zonal Flux Diagram

T	C0	C45	C90	C135	C180
10	1038	919.6	732.9	585.3	554.5
20	1209	984.8	638.0	411.7	353.7
30	1192	930.7	494.7	267.4	210.7
40	1053	743.2	354.7	155.9	97.27
50	896.8	548.9	205.7	66.71	21.28
60	526.2	310.4	73.90	12.46	5.292
70	136.0	73.16	14.65	4.282	4.094
80	12.17	4.784	1.600	3.400	3.395
90	0.1674	0.0925	0.0768	0.1779	0.0947
100	0.0812	0.0812	0.1175	0.2143	0.3070
110	0.0631	0.0925	0.1760	0.5996	0.7989
120	1.081	0.1646	0.3880	1.220	1.633
130	0.1577	0.2909	0.6721	1.526	2.147
140	0.3513	0.4938	0.9789	1.914	2.359
150	0.6173	0.7667	1.276	2.081	2.534
160	0.9781	1.127	1.565	2.182	2.530
170	1.433	1.522	1.781	2.153	2.340
180	1.935	1.851	1.826	1.847	1.944
DEG	LUMINOUS INTENSITY:cd				

### Zonal Lumens

T	φ total
0-10	73.89
10-20	284.3
20-30	592.3
30-40	929.2
40-50	1235
50-60	1461
60-70	1563
70-80	1584
80-90	1586
90-100	1586
100-110	1586
110-120	1587
120-130	1588
130-140	1588
140-150	1589
150-160	1590
160-170	1590
170-180	1591
	UNIT: lm

### Luminance cd/(m2)

G(DEG)	C0/180	C90/270
85	373	694
80	3114	410
75	9473	779
70	17677	1904
65	31770	3741
60	46776	6569
55	57281	10368
50	62005	14225
45	61916	17780

# LJD

## 6" 40W Round Trim

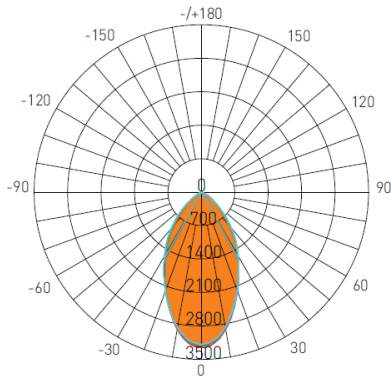

AVERAGE BEAM ANGLE(50%): 57.4°

Lumens: 3328.0 Lm  
 Watts: 40 W  
 LPW: 83.2 Lm/W  
 CCT: 4000K

UNIT: cd  
 C0/180,56.4°  
 C30/210,56.9°  
 C60/240,57.9°  
 C90/270,58.4°

### Zonal Flux Diagram

T	C0	C45	C90	C135	C180
10	2916	2896	2871	2857	2912
20	2201	2209	2188	2161	2186
30	1521	1544	1542	1506	1498
40	891.0	956.2	972.7	929.2	869.3
50	335.4	424.5	441.2	395.6	321.0
60	58.83	91.82	97.54	78.63	54.01
70	3.285	2.050	1.504	1.915	3.235
80	1.606	0.8562	0.5011	0.8066	1.591
90	0.1094	0.0676	0.0949	0.0811	0.0721
100	0.0902	0.0812	0.0857	0.0992	0.0993
110	0.1532	0.2302	0.2280	0.2212	0.1986
120	0.5046	0.6317	0.6711	0.6273	0.5778
130	1.262	1.372	1.496	1.403	1.359
140	2.366	2.405	2.542	2.450	2.455
150	3.683	3.717	3.809	3.735	3.735
160	5.157	5.110	5.117	5.088	5.184
170	6.245	6.183	6.145	6.160	6.273
180	6.732	6.710	6.593	6.620	6.755
DEG	LUMINOUS INTENSITY:cd				

### Zonal Lumens

T	φ total
0-10	289.3
10-20	997.9
20-30	1840
30-40	2601
40-50	3101
50-60	3290
60-70	3317
70-80	3318
80-90	3319
90-100	3319
100-110	3319
110-120	3320
120-130	3320
130-140	3322
140-150	3324
150-160	3326
160-170	3327
170-180	3328
DEG	UNIT: lm

### Luminance cd/(m2)

G[DEG]	C0/180	C90/270
85	742	162
80	524	163
75	497	189
70	544	249
65	1661	3557
60	6661	11045
55	15820	22953
50	29545	38863
45	47042	55891

## 6" 40W Round Wall Wash

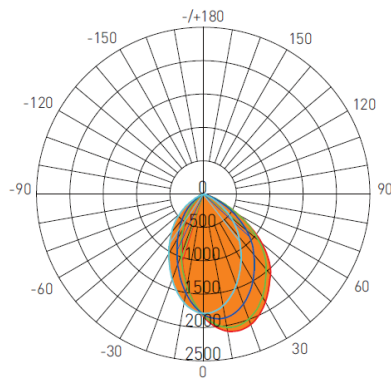

AVERAGE BEAM ANGLE(50%): 71.0°

Lumens: 2949.1 Lm  
 Watts: 40 W  
 LPW: 73.73 Lm/W  
 CCT: 3000K

UNIT: cd  
 C0/180,69.2°  
 C30/210,70.4°  
 C60/240,72.4°  
 C90/270,72.2°

### Zonal Flux Diagram

T	C0	C45	C90	C135	C180
10	2085	1962	1700	1461	1397
20	2080	1892	1449	1069	944.4
30	1866	1658	1132	716.4	584.0
40	1572	1343	828.3	446.7	318.6
50	1152	1001	540.1	222.7	107.6
60	593.4	562.8	253.7	36.59	12.99
70	169.5	186.5	59.76	4.875	5.799
80	4.680	16.81	1.576	1.973	2.586
90	0.0996	0.0631	0.0831	0.1709	0.1311
100	0.0811	0.0677	0.1123	0.2708	0.3476
110	0.0812	0.1309	0.3018	0.6949	0.9297
120	0.2162	0.3294	0.7163	1.394	1.832
130	0.4958	0.6814	1.271	2.125	2.851
140	0.9914	1.173	1.857	2.832	3.771
150	1.650	1.822	2.520	3.504	4.325
160	2.502	2.603	3.201	3.991	4.613
170	3.422	3.432	3.765	4.225	4.744
180	4.216	4.104	4.000	4.054	4.230
DEG	LUMINOUS INTENSITY:cd				

### Zonal Lumens

T	φ total
0-10	166.4
10-20	610.3
20-30	1207
30-40	1830
40-50	2383
50-60	2750
60-70	2907
70-80	2940
80-90	2941
90-100	2941
100-110	2942
110-120	2942
120-130	2943
130-140	2945
140-150	2946
150-160	2948
160-170	2949
170-180	2949
DEG	UNIT: lm

### Luminance cd/(m2)

G[DEG]	C0/180	C90/270
85	182	531
80	1526	514
75	14095	3272
70	28056	9893
65	45639	18782
60	67192	28730
55	86754	38552
50	101454	47569
45	111057	55165

6" 60W Round Trim

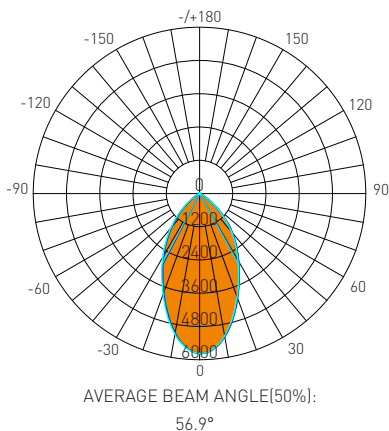

Lumens: 6080.5 Lm  
 Watts: 60 W  
 LPW: 105.62 Lm/W  
 CCT: 4000K

UNIT: cd  
 C0/180,56.9  
 C30/210,56.9  
 C60/240,56.9  
 C90/270,57.1

Zonal Flux Diagram

τ	C0	C45	C90	C135	C180
10	5234	5256	5211	5157	5112
20	4001	4030	3965	3873	3798
30	2811	2846	2776	2693	2616
40	1791	1860	1784	1668	1555
50	764.7	867.3	846.4	732.7	625.5
60	131.8	177.2	187.4	148.0	114.0
70	2.926	2.726	2.774	2.690	2.956
80	1.046	0.9556	1.165	1.244	1.296
90	0.9362	0.9751	1.060	1.237	0.5501
100	2.605	2.577	2.790	3.024	1.718
110	5.634	5.497	5.834	6.187	4.246
120	10.14	9.931	10.37	10.83	8.178
130	15.96	15.64	16.15	16.63	13.30
140	22.23	21.84	22.31	22.73	19.11
150	27.81	27.32	27.71	27.98	24.72
160	32.27	31.80	32.01	32.24	29.85
170	35.31	35.05	35.00	35.13	33.99
180	36.50	36.61	36.18	36.24	36.48

LUMINOUS INTENSITY:cd

Zonal Lumens

τ	φ btal
0-10	521.5
10-20	1795
20-30	3302
30-40	4671
40-50	5594
50-60	5952
60-70	6001
70-80	6003
80-90	6004
90-100	6005
100-110	6009
110-120	6016
120-130	6027
130-140	6040
140-150	6055
150-160	6068
160-170	6077
170-180	6080

UNIT: lm

Luminance cd/(m2)

G(DEG)	C0/180	C90/270
85	503	597
80	343	381
75	383	379
70	487	461
65	3558	5987
60	15005	21281
55	36550	45136
50	67697	74783
45	101909	104814